

# LG Series - Strip Light Wire Guards

catalogue number	gauge	performance	size "A"
<b>LGS series,</b>			
<b>LGS-14-2</b>	14	light duty	2"
<b>LGS-14-3</b>	14	light duty	3"
<b>LGS-14-4</b>	14	light duty	4"
<b>LGS-14-5</b>	14	light duty	5"
<b>LGS-14-7</b>	14	light duty	7"
<b>LGS-14-8</b>	14	light duty	8"
<b>LGS-14-10</b>	14	light duty	10"
<b>LGS-11 series,</b>			
<b>LGS-11-2</b>	11	heavy duty	2"
<b>LGS-11-3</b>	11	heavy duty	3"
<b>LGS-11-4</b>	11	heavy duty	4"
<b>LGS-11-5</b>	11	heavy duty	5"
<b>LGS-11-7</b>	11	heavy duty	7"
<b>LGS-11-8</b>	11	heavy duty	8"
<b>LGS-11-10</b>	11	heavy duty	10"
<b>LGSO series,</b>			
<b>LGSO-14-7</b>	14	light duty	7"
<b>LGSO-14-9</b>	14	light duty	9"
<b>LGSO-11-7</b>	11	heavy duty	7"
<b>LGSO-11-9</b>	11	heavy duty	9"
<b>TSMC</b>	mounting clips		10 per bag

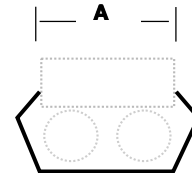

**LGS SERIES**

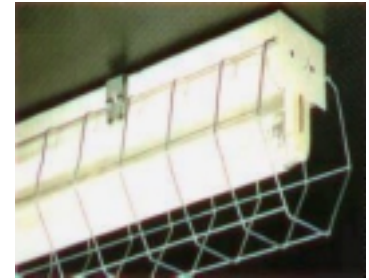
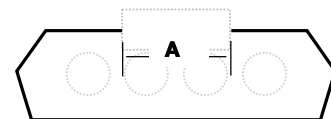

**LGSO SERIES**

## Product Overview

- 11 gauge Heavy Duty; 14 gauge Light Duty.
- Chrome epoxy finish standard.
- Mounting hardware included.
- Full product offering.



**mounting hardware included**

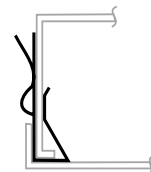

# LGR Series - Industrial Wire Guards

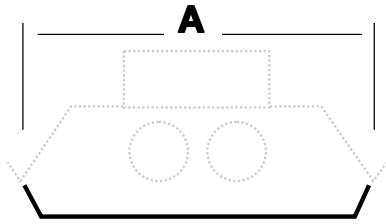
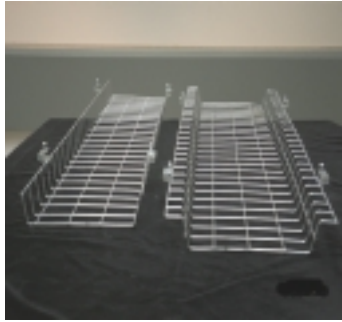

**LGRS  
Standard Series**

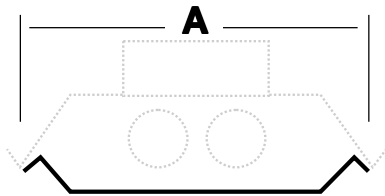

**LGRP  
Low Profile Series**



**mounting hardware  
included**

catalogue number	gauge	performance	size "A"
------------------	-------	-------------	----------

***LGRS series,***

<b>LGRS-14-6</b>	14	light duty	6"
<b>LGRS-14-8</b>	14	light duty	8"
<b>LGRS-14-10</b>	14	light duty	10"
<b>LGRS-14-12</b>	14	light duty	12"
<b>LGRS-14-14</b>	14	light duty	14"
<b>LGRS-11-6</b>	11	heavy duty	6"
<b>LGRS-11-8</b>	11	heavy duty	8"
<b>LGRS-11-10</b>	11	heavy duty	10"
<b>LGRS-11-12</b>	11	heavy duty	12"
<b>LGRS-11-14</b>	11	heavy duty	14"

***LGRP series,***

<b>LGRP-14-10</b>	14	light duty	10"
<b>LGRP-14-12</b>	14	light duty	12"
<b>LGRP-14-14</b>	14	light duty	14"
<b>LGRP-14-16</b>	14	light duty	16"
<b>LGRP-11-10</b>	11	heavy duty	10"
<b>LGRP-11-12</b>	11	heavy duty	12"
<b>LGRP-11-14</b>	11	heavy duty	14"
<b>LGRP-11-16</b>	11	heavy duty	16"
<b>LGRMH</b>	mounting hardware (6 per bag)		

**Product Overview**

- 11 gauge Heavy Duty; 14 gauge Light Duty.
- Chrome epoxy finish standard.
- Mounting hardware included.
- Full product offering.

***How To Order Your Convex Striplight Guards***

- 1) - Size the width of your strip by measuring the reflector as indicated below.
- 3) - Select your gauge.
- 4) - Select your guard from the above list.

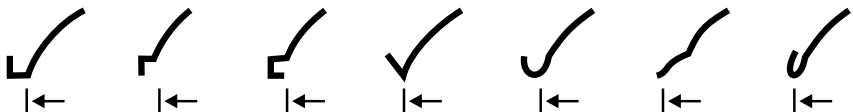

# CFG Series - Ceiling Fan Wire Guards

catalogue number	fan diameter	guard diameter
WG-CFG-36	36"	40"
WG-CFG-48	48"	52"
WG-CFG-56	56"	60"
WG-CFG-60	60"	64"



## Product Overview

- Constructed with tempered sealed wire.
- Comes in chrome epoxy finish, but other colors may be available.
- Coating is very durable and weather resistant.

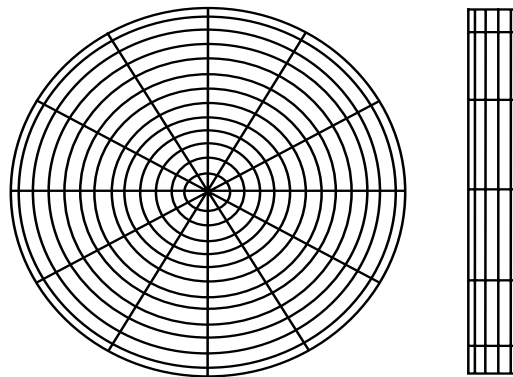

# CG Series - Clock Wire Guards

catalogue number	diameter	depth
WG-CG-12	12"	4"
WG-CG-14	14"	4"
WG-CG-16	16"	4"
WG-CG-18	18"	4"



## Product Overview

- Made with 11 gauge wire.
- Depth allows for clocks up to 3" in deep.
- Nylon hinge clips are supplied for mounting.
- Coating is weather resistant.

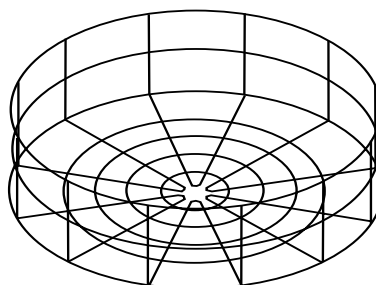

## ELG Series - Emergency Light Wire Guards



catalogue number	width	height	depth
<b>WG-ELG-13125</b>	13"	12"	5"
<b>WG-ELG-14155</b>	14"	15"	5"
<b>WG-ELG-17169</b>	17"	16"	9"
<b>WG-ELG-261810</b>	26"	18"	10"

### PROFILE

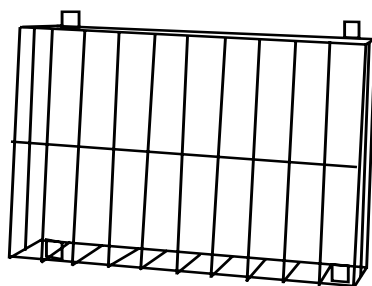

## EX Series - Exit Sign Wire Guards

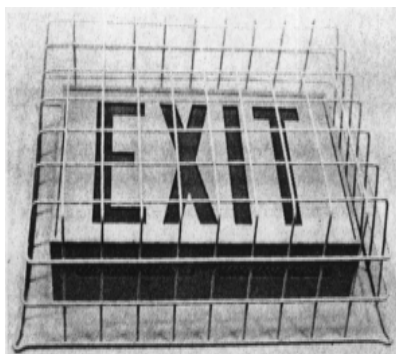

catalogue number	width	height	depth
<b>WG-EX-1483</b>	14"	8"	3"
<b>WG-EX-1494</b>	14"	9"	4"
<b>WG-EX-14164</b>	14"	16"	4"
<b>LX-EX-14-8-3</b>	clear lexan exit guard		

### PROFILE

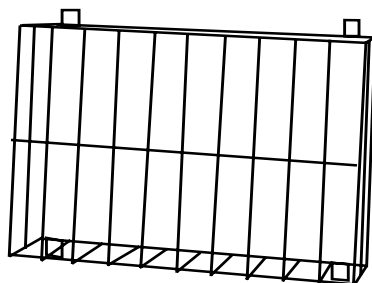

# LB Series - Low Bay Wire Guards

catalogue number	diameter "A"	depth "B"
WG-LB-1-XX	12 -13"	5"
WG-LB-2-XX	14-16"	5"
WG-LB-3-XX	17-18"	5"
WG-LB-4-XX	19-21"	5"
WG-LB-5-XX	22-24"	5"

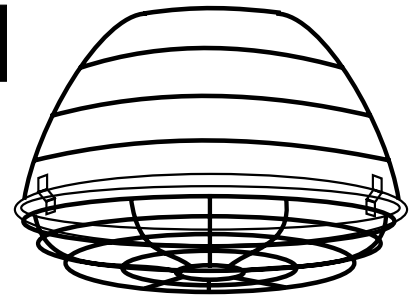

## Product Overview

- XX = diameter; when ordering please specify diameter.
- Constructed with 11ga. tempered steel wire.
- Steel hinges are attached making installation easy.
- Guards are quite weather resistant.

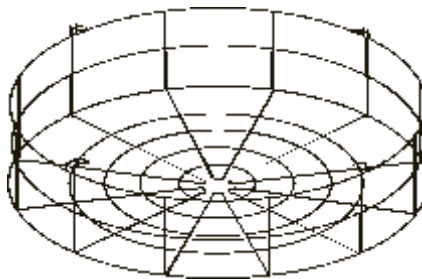

# HB Series - High Bay Wire Guards

catalogue number	diameter "A"
WG-HB-1-XX	12" or 13"
WG-HB-2-XX	14",15" or 16"
WG-HB-3-XX	17", 18" or 19"
WG-HB-4-XX	20" or 21"
WG-HB-5-XX	22", 23" or 24"

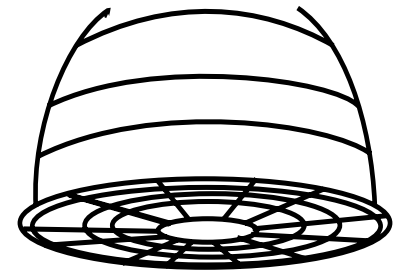

## Product Overview

- XX = diameter; when ordering please specify diameter.
- Constructed with 11ga. tempered steel wire.
- Steel hinges makes installation easy; guards are weather resistant.

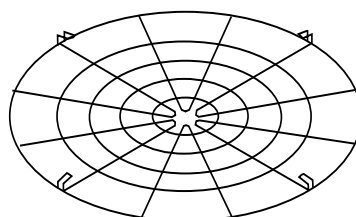

# C34 Series - Fold-Out Wire Guards

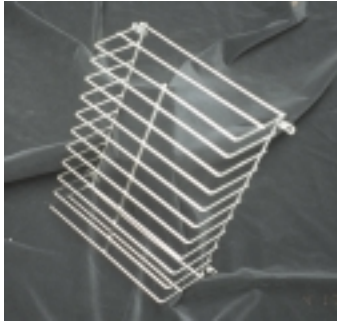

catalogue number	dimensions		
	width	height	depth
<b>Stock HEAVY DUTY Guards,</b>			
<b>WG-C3406</b>	27 1/2"	12"	14 1/2"
<b>WG-C3414</b>	15"	18"	10"
<b>WG-C3416</b>	18"	15"	6"
<b>WG-C3418</b>	21"	23"	12"
<b>WG-C3424</b>	32"	21"	12"
<b>WG-C3429</b>	16"	16"	14"
<b>WG-C3430</b>	16"	26"	14"
<b>WG-C3431</b>	16"	16"	9"
<b>WG-C3432</b>	8"	8"	8"
<b>WG-C3433</b>	16"	8"	8"
<b>WG-C3434</b>	13 3/8"	13 3/4"	4 3/8"
<b>WG-C3435</b>	13 5/8"	4"	16 3/4"
<b>WG-C3436</b>	27 1/2"	4"	8"
<b>WG-C3438</b>	21"	15"	6"

## Product Overview

- Fold down to 1" depth for easy handling.
- Chrome epoxy finish standard.
- 11 gauge heavy duty.
- Mounting hardware included where specified.
- Full product offering.

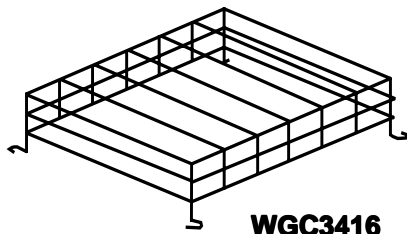

**WGC3416**

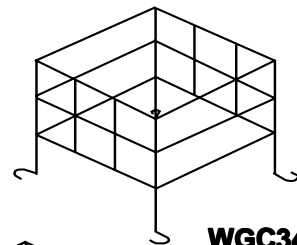

**WGC3432**

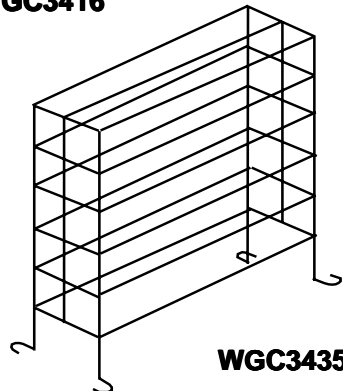

**WGC3435**

# Standard Stocked HID Wire Guards

catalogue number	width	dimensions height	depth
<b>Stock HEAVY DUTY Guards,</b>			
WG-C10106	10"	10"	6"
WG-C121010	12"	10"	10"
WG-C12128	12"	12"	8"
WG-C14146	14"	14"	6"
WG-C161010	16"	10"	10"
WG-C161610	16"	16"	10"
WG-C161810	16"	18"	10"
WG-C181610	18"	16"	10"
WG-C261810	26"	18"	10"
WG-WRAPGUARD	11 1/2"	52" (LONG)	5 1/5"

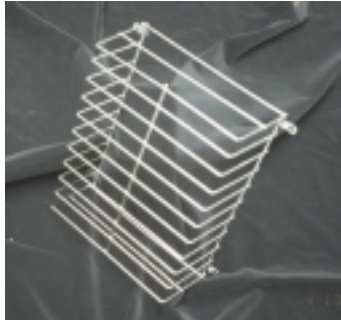

## Can't Find Your Size?

We can make to measure  
Fill in the blanks and fax (780) 452-5734

**Company Name:** \_\_\_\_\_

**Contact:** \_\_\_\_\_

**Ph:** \_\_\_\_\_

**Fax:** \_\_\_\_\_

**Quantity Required:** \_\_\_\_\_

**Finish:** white \_\_\_\_\_ chrome epoxy coat \_\_\_\_\_

Material will be 11 gauge with a 1/4" diameter rim construction

A = \_\_\_\_\_

B = \_\_\_\_\_

C = \_\_\_\_\_

CVX200A.1